

Canada
Art. Nr. 060411.1UK
1/26

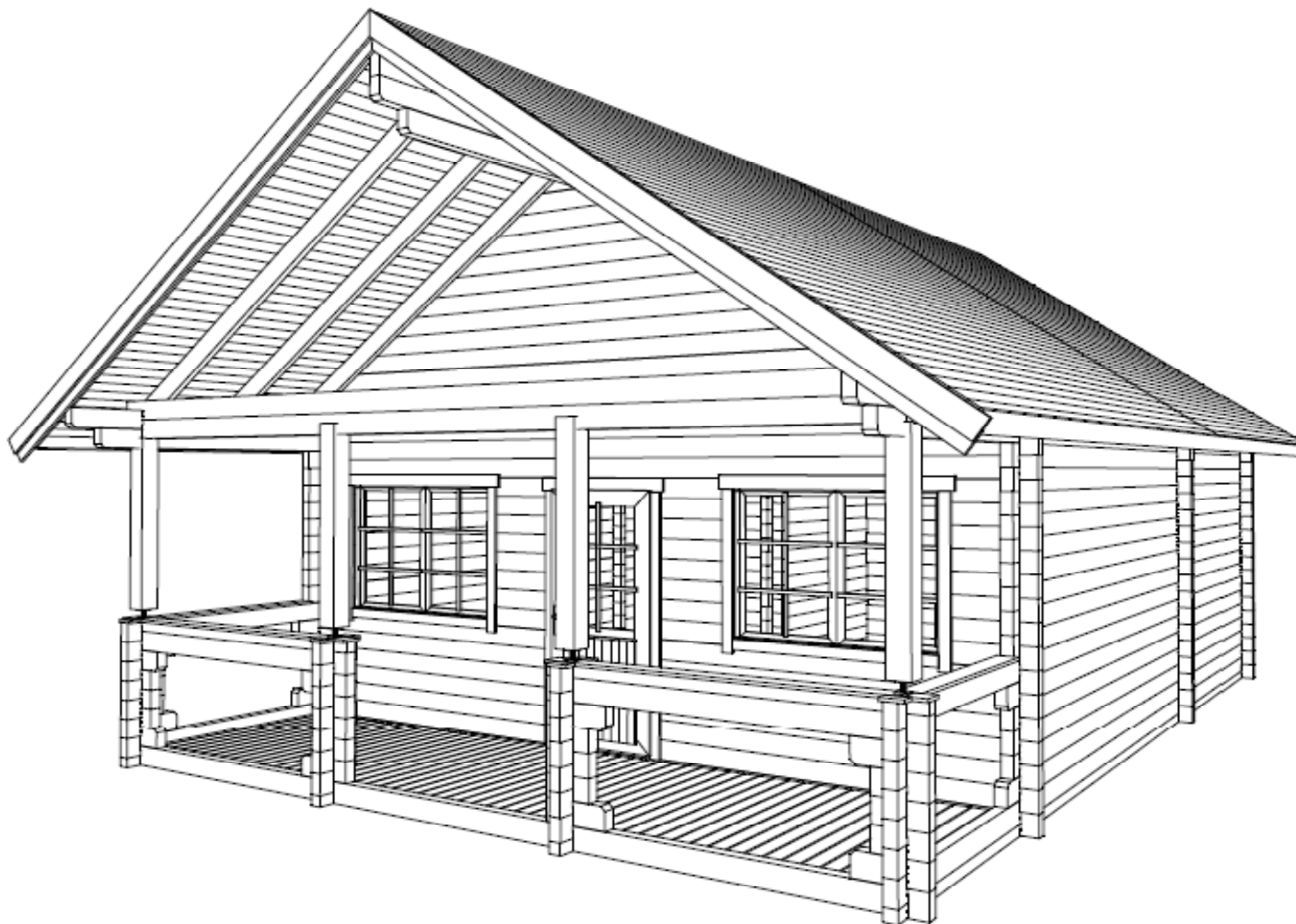

70x136
15.04.2011

GROUNDPLAN - GRUNDPLAN - PLAN DE MASSE

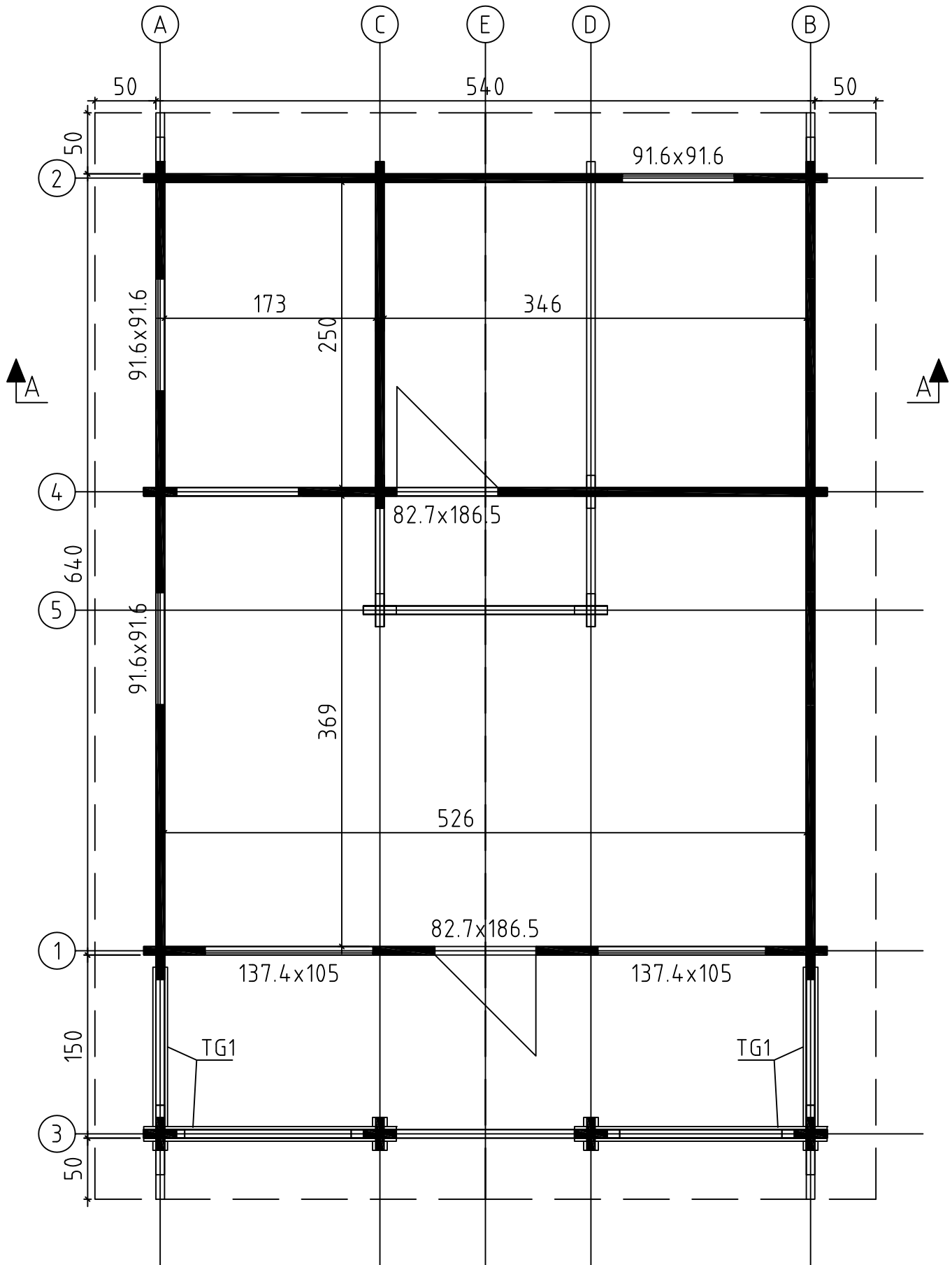

FOUNDATION - FUNDAMENT - FONDATION

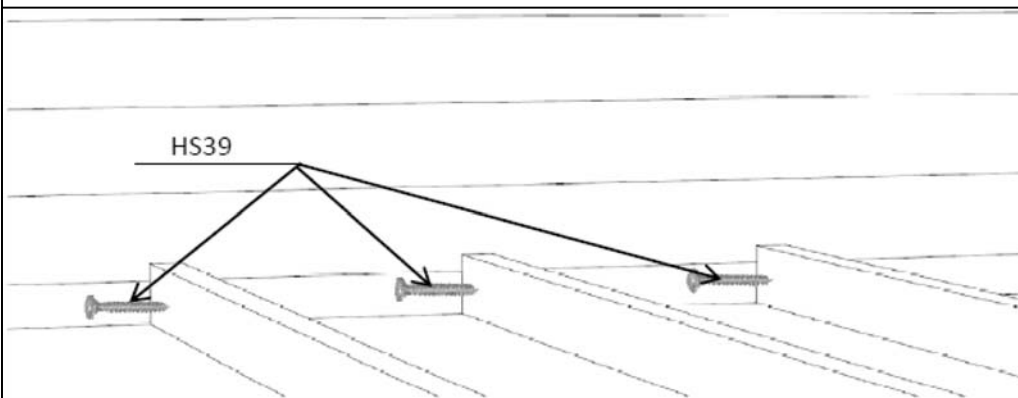
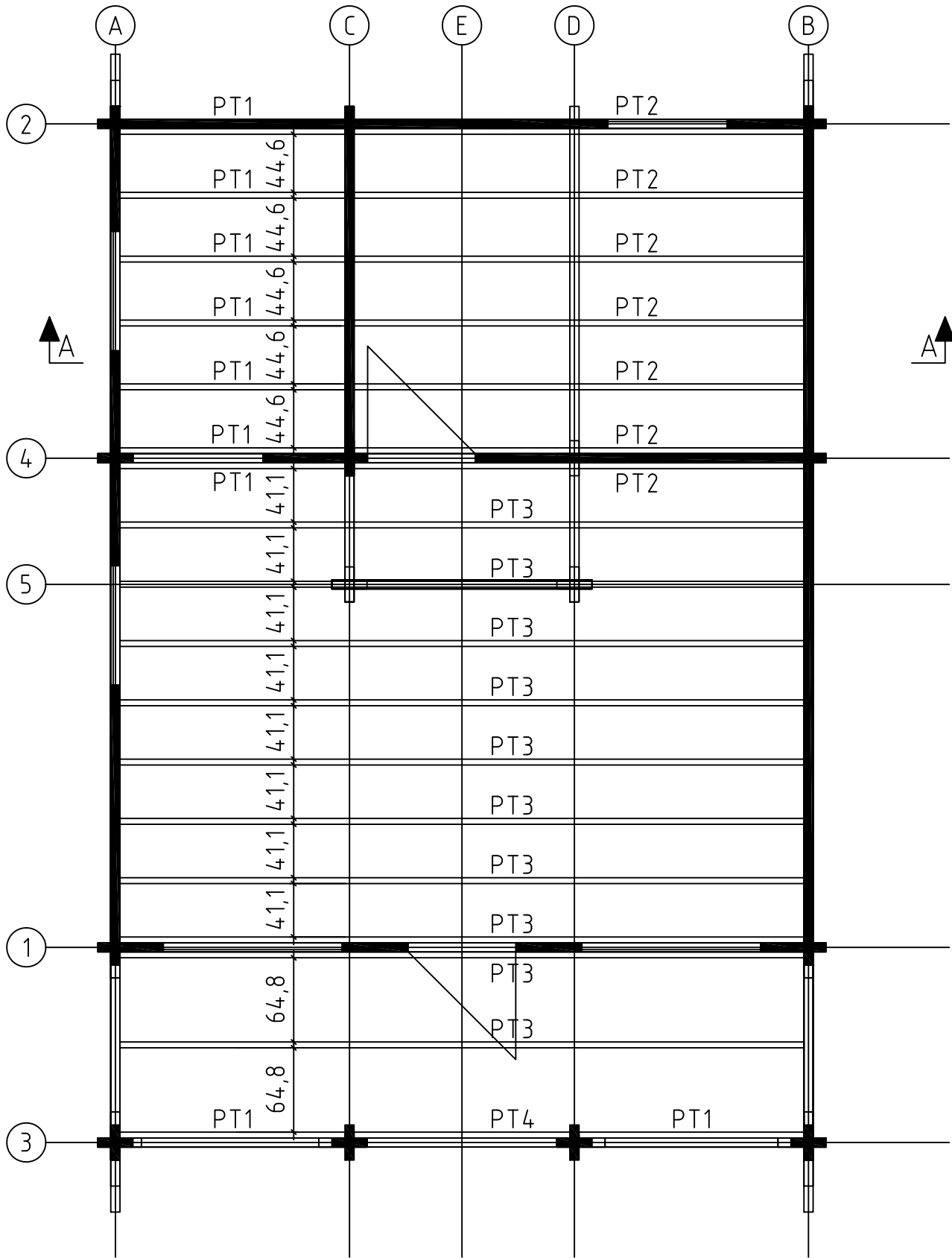

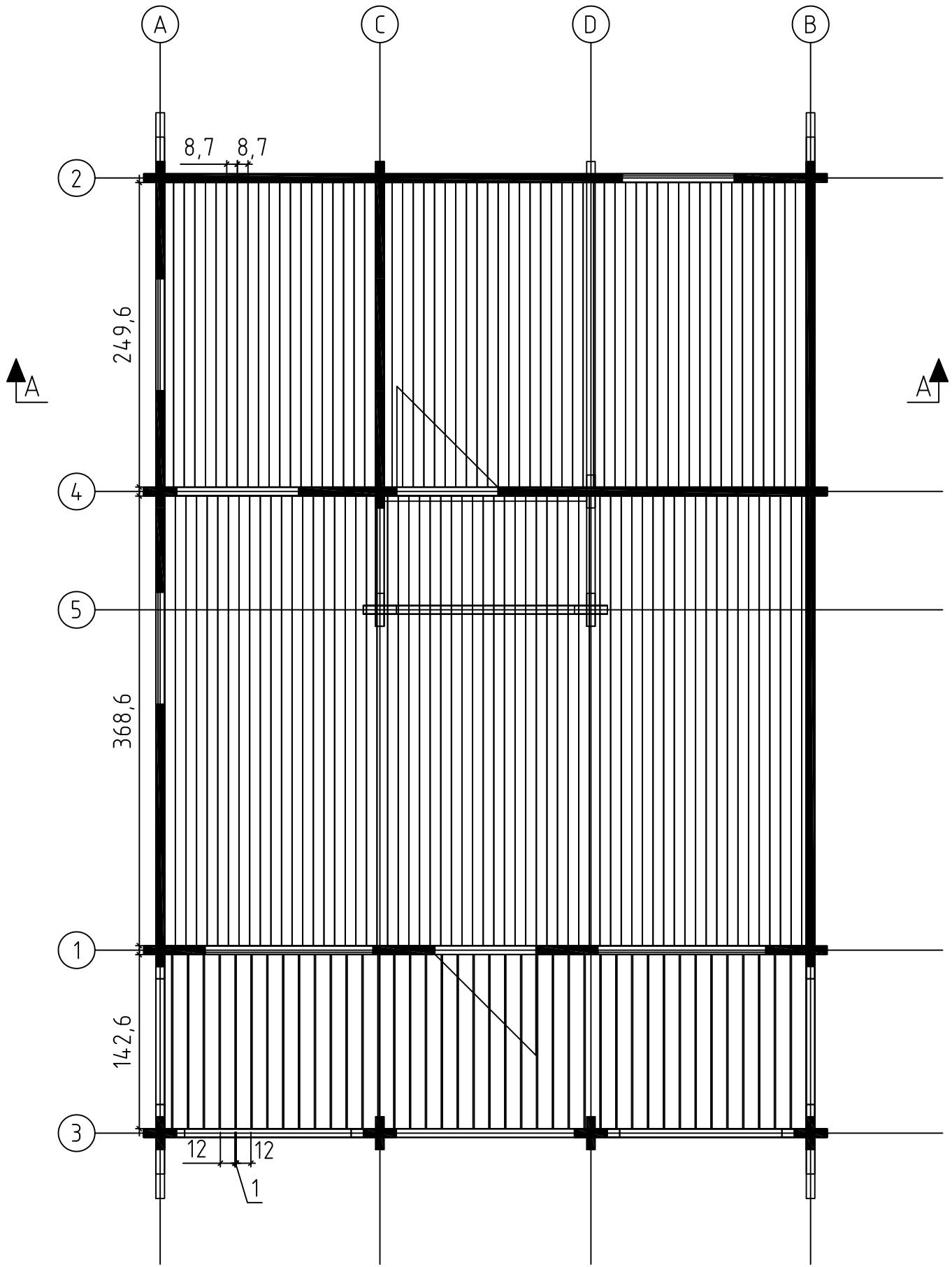

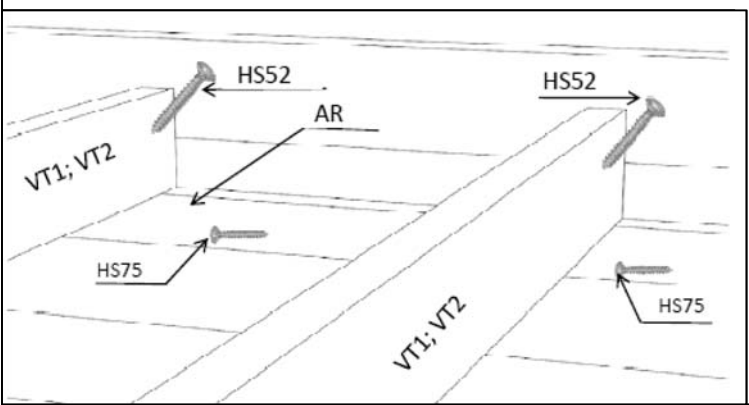
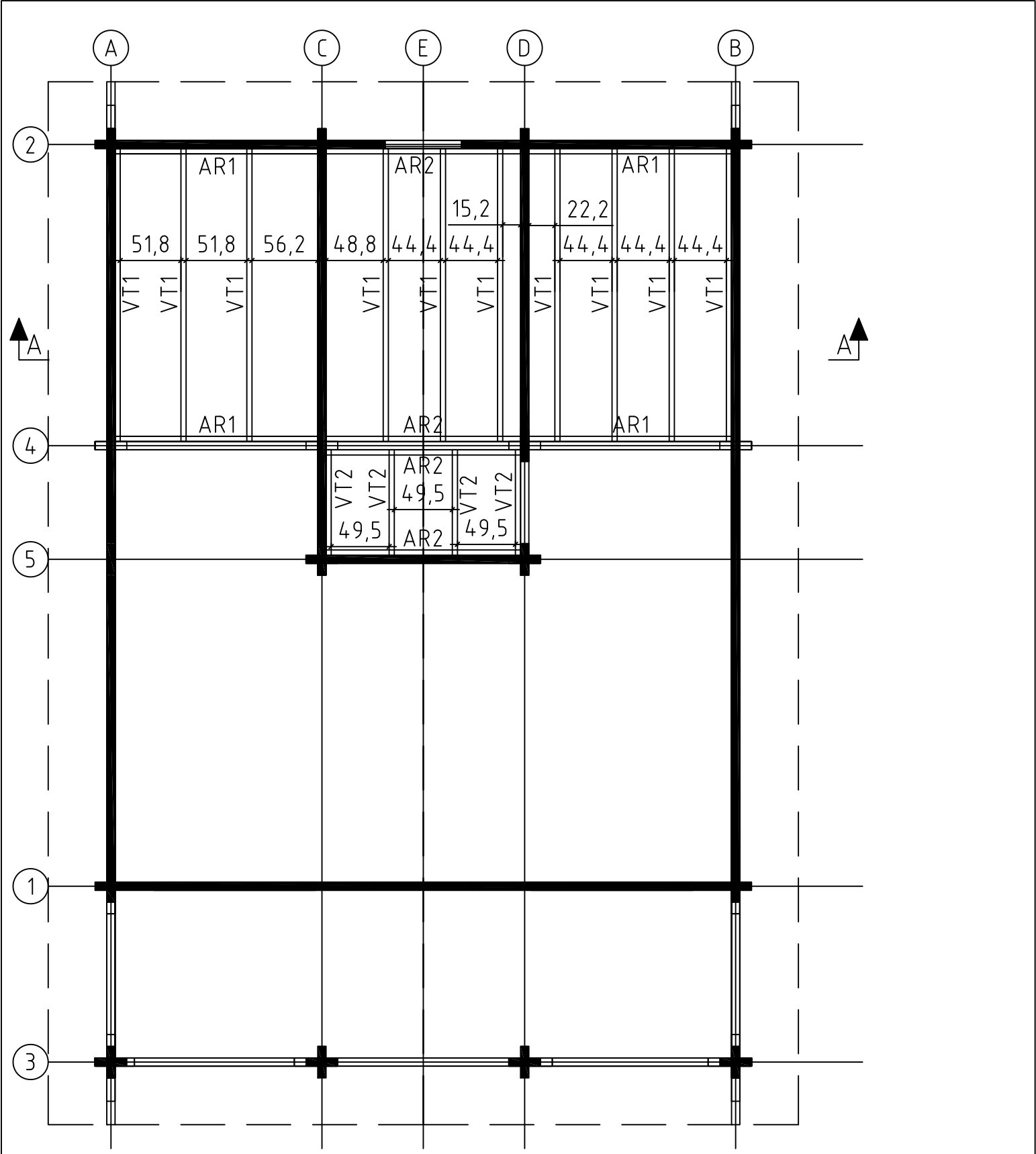

FLOOR BOARDS - FUSSBODENBRETTER - PLAN POSE PLANCHER

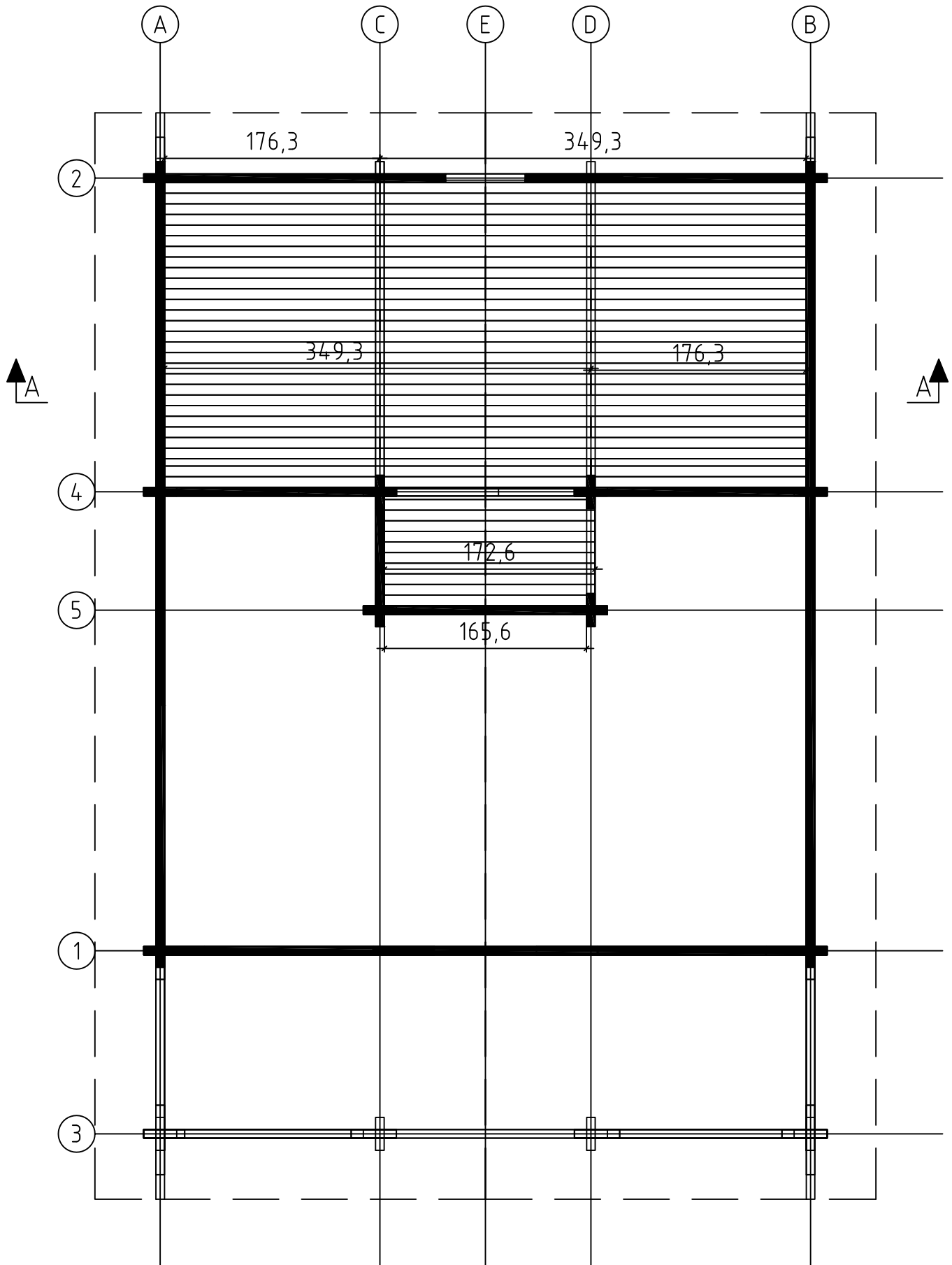

RAFTERS PLAN - DACHSPARREN - PLAN DE CHEVRON

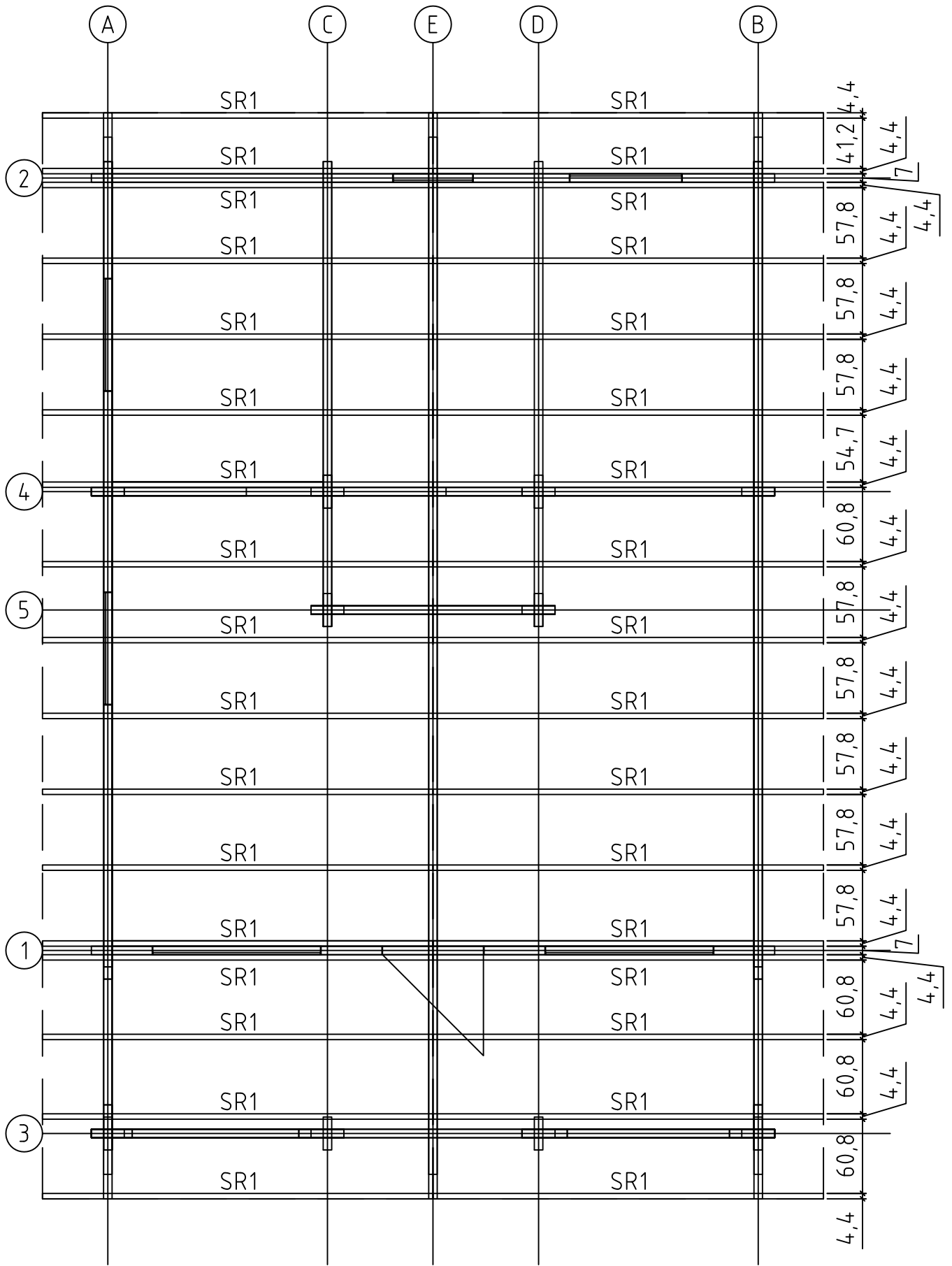

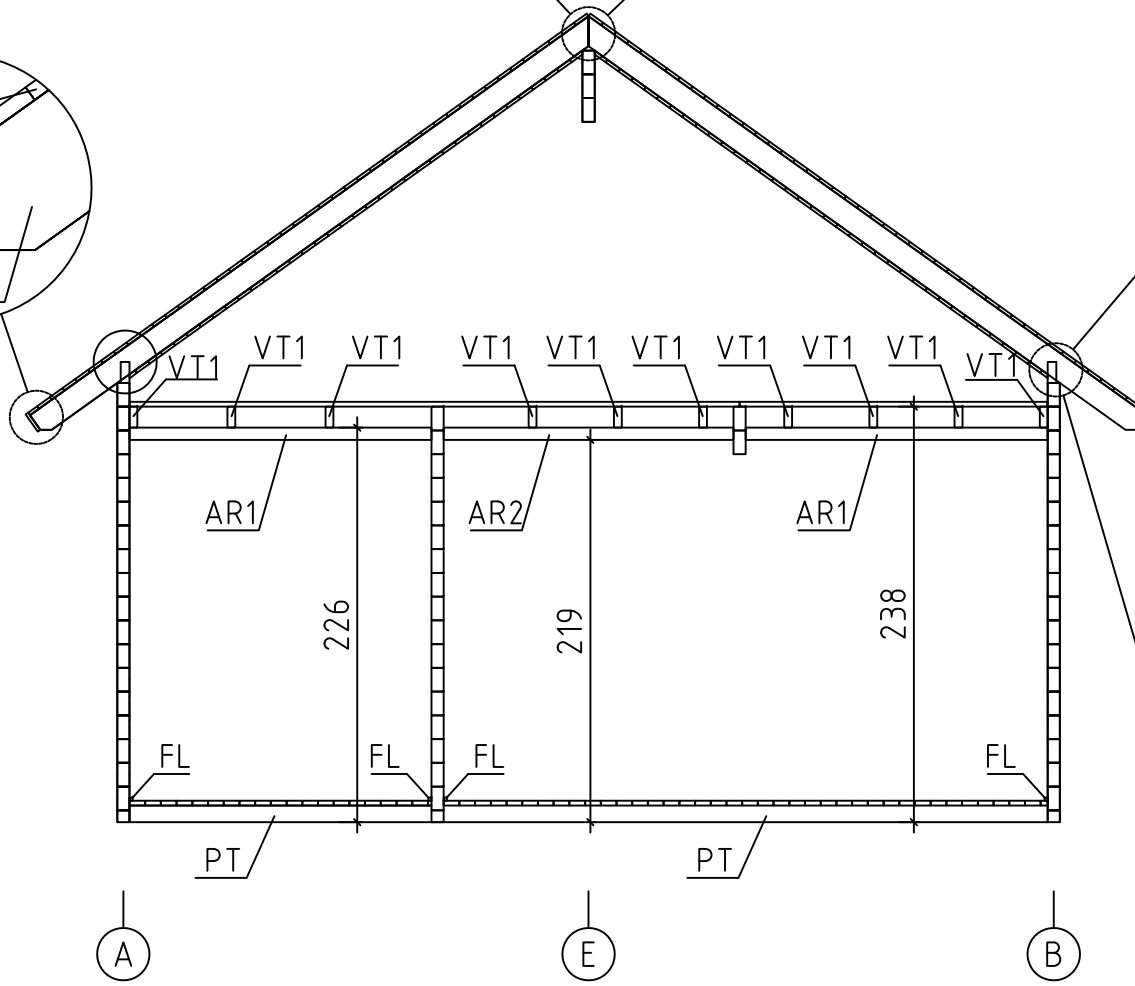
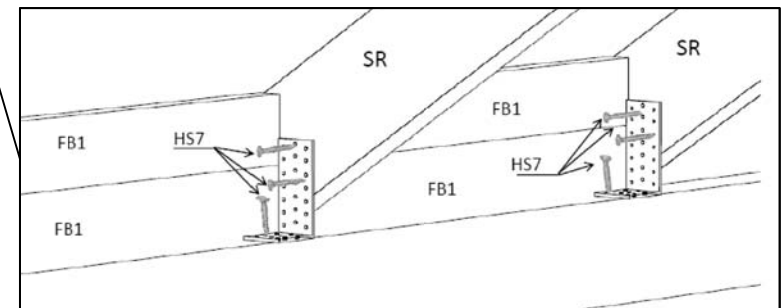
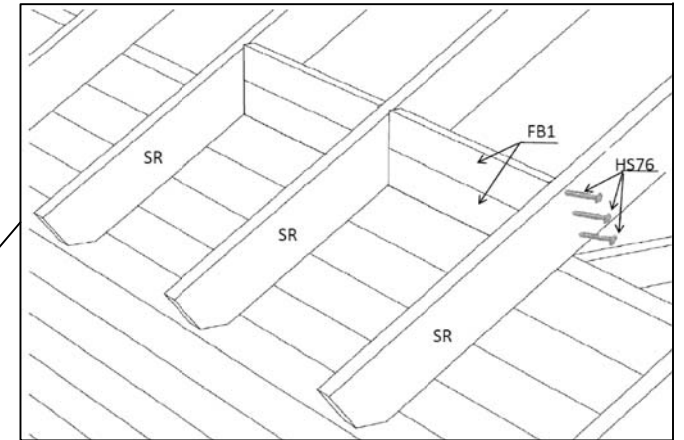
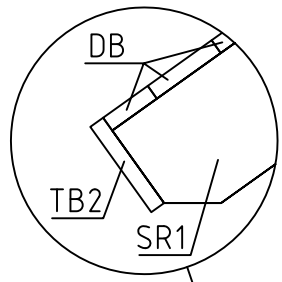
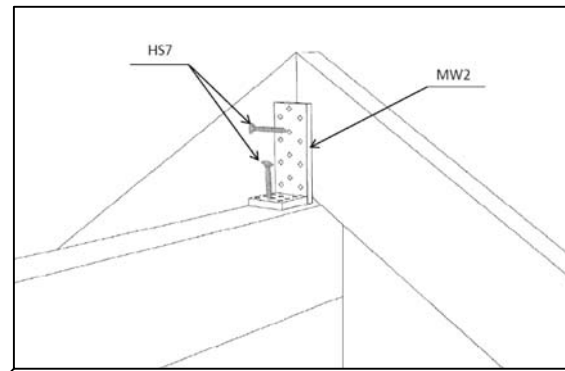
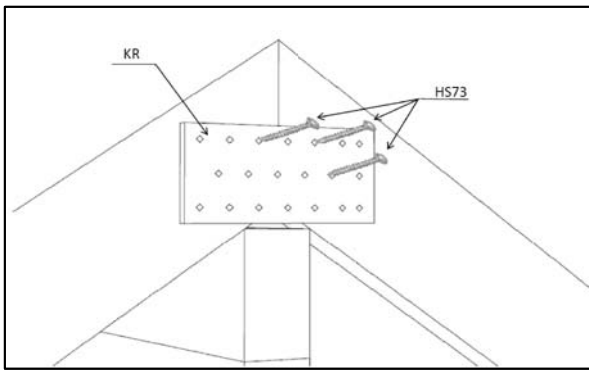

FIXING FILLET (TBE6) FOR WINDOW AND DOOR - FIXIRUNGSLEISTE (TBE6) FÜR FENSTER UND TÜR
PROFIL DE FIXATION DES FENÊTRES ET PORTES (TBE6)

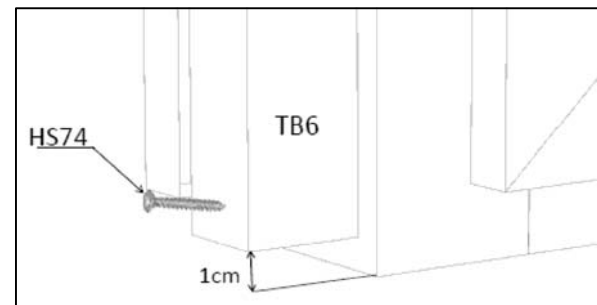
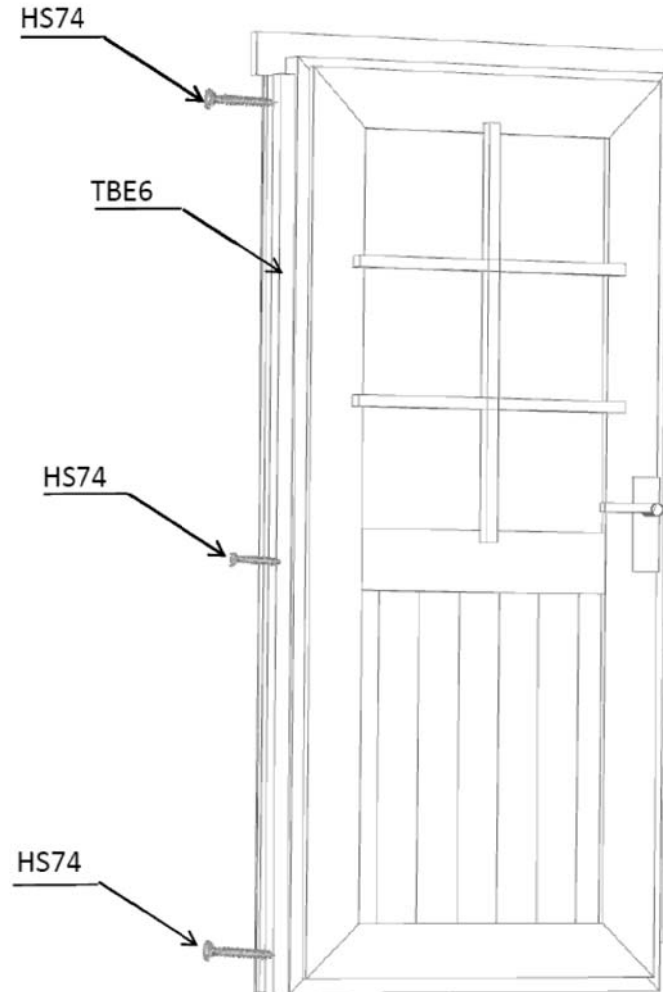
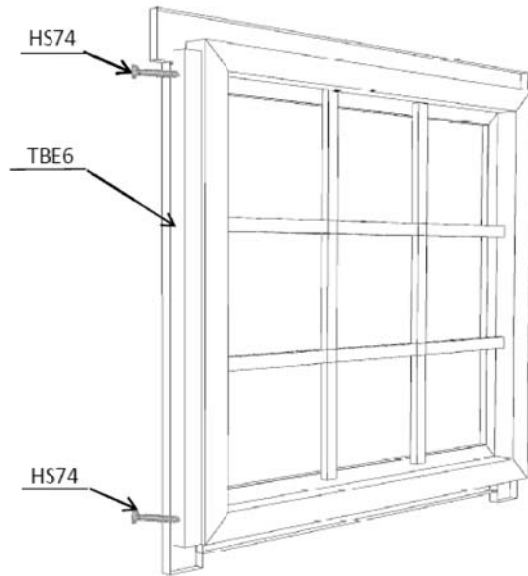

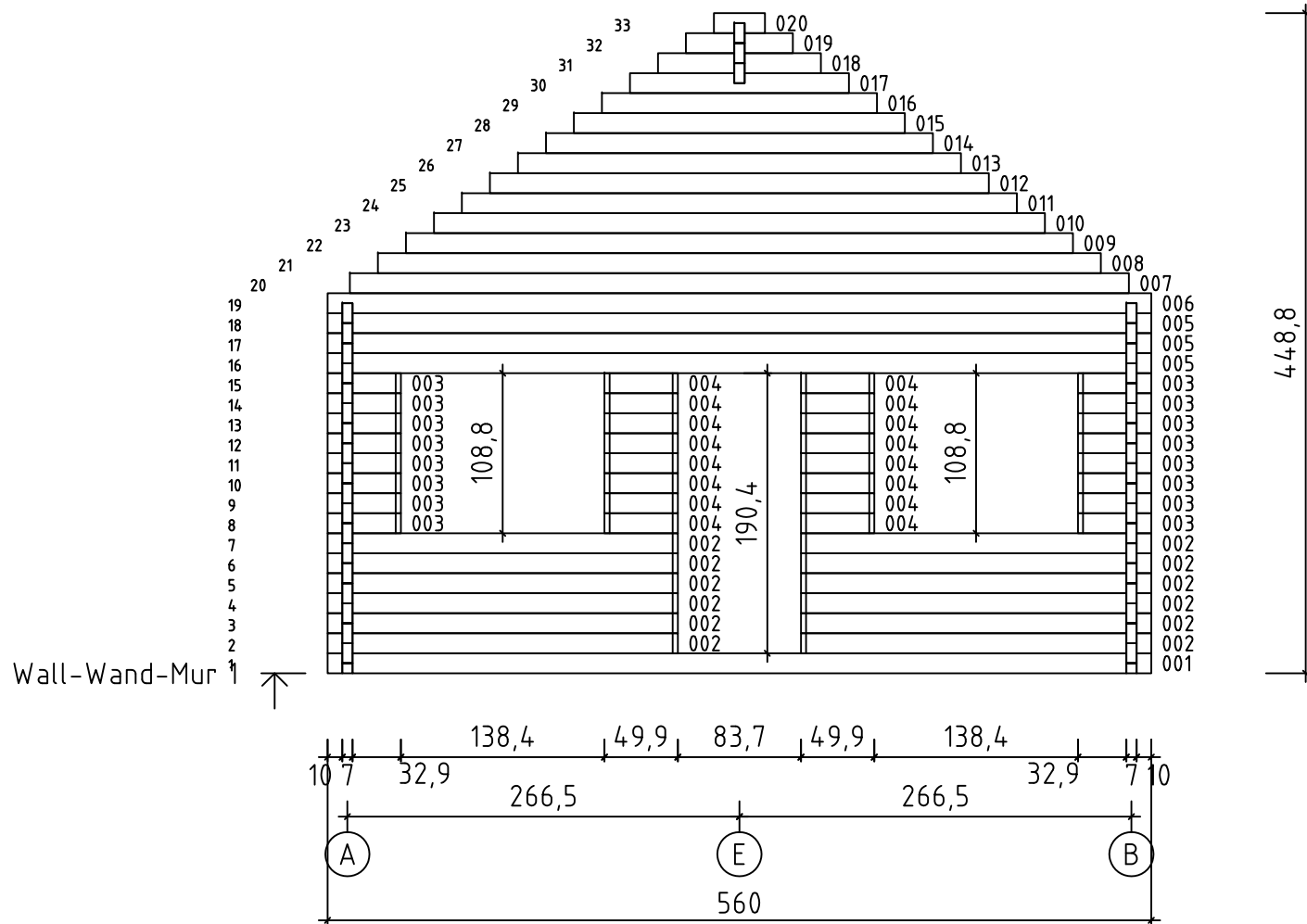

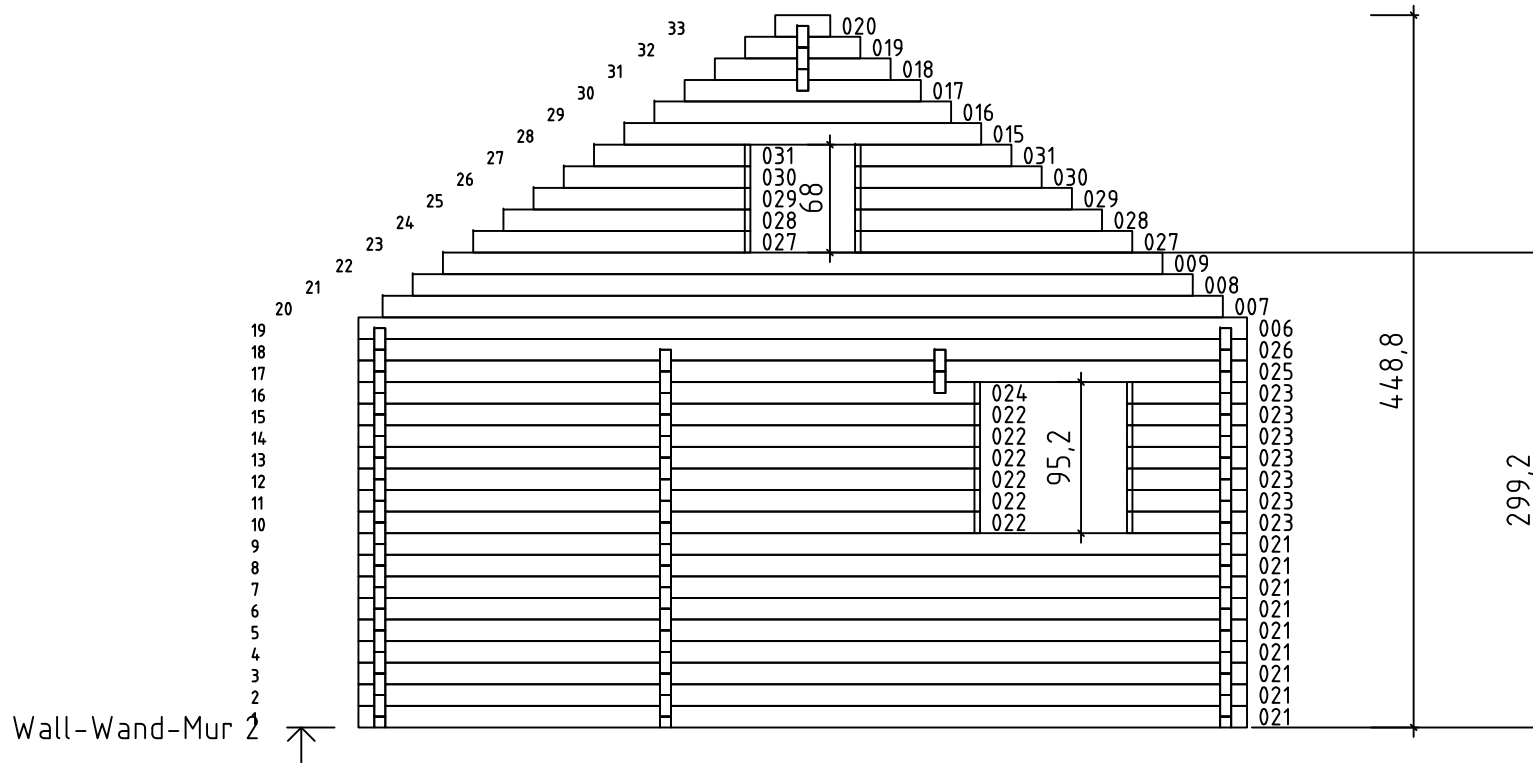

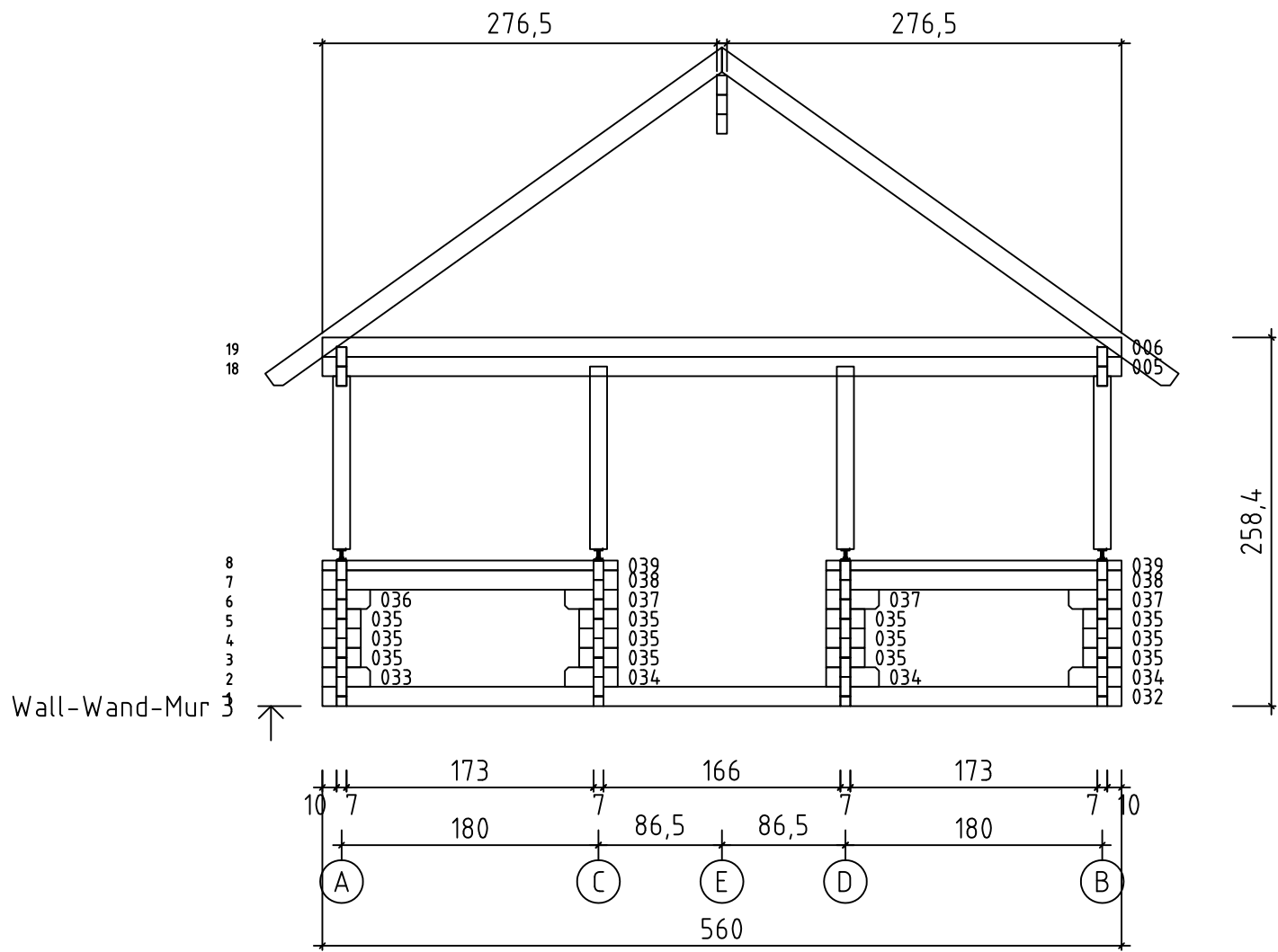

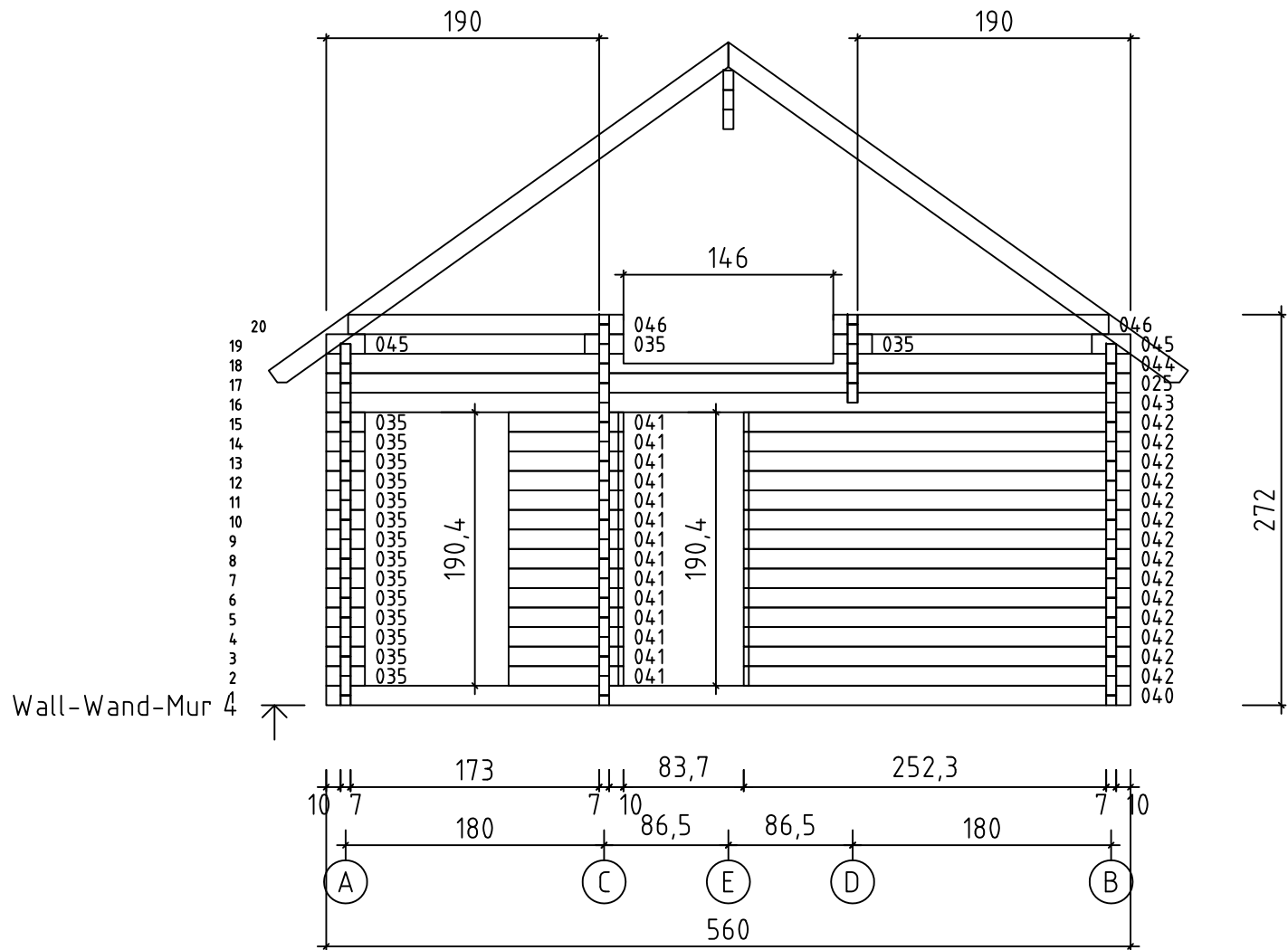

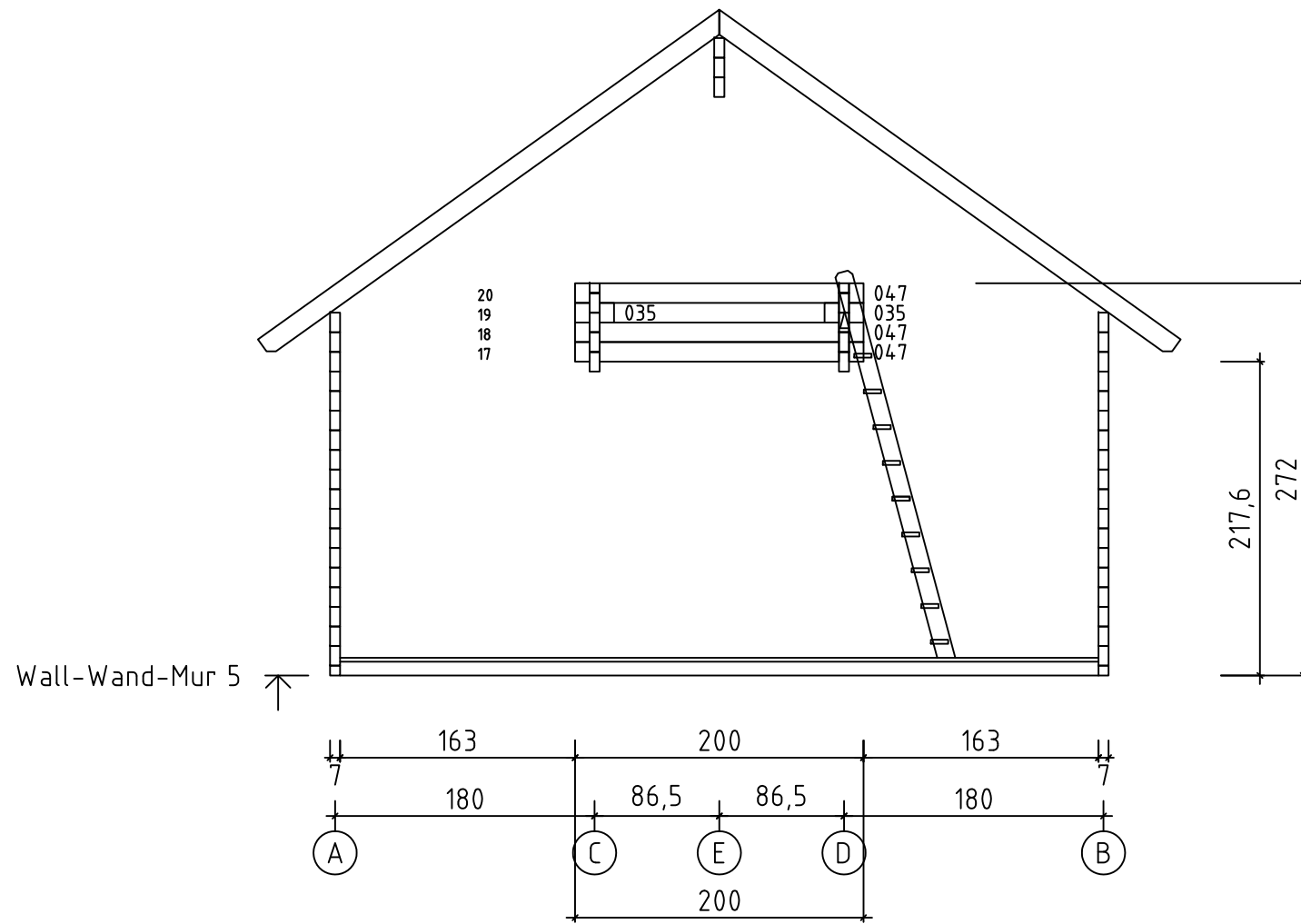

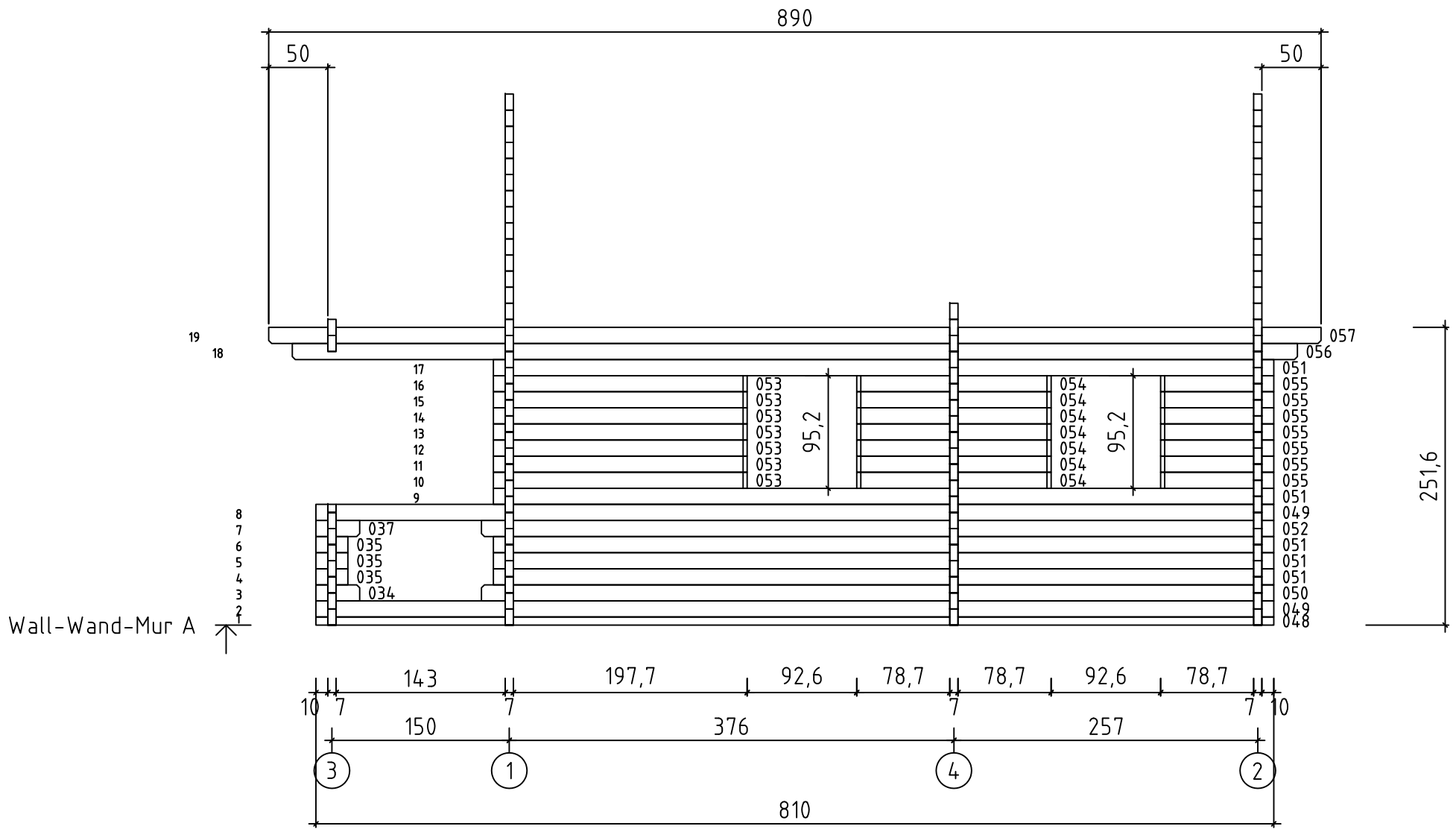

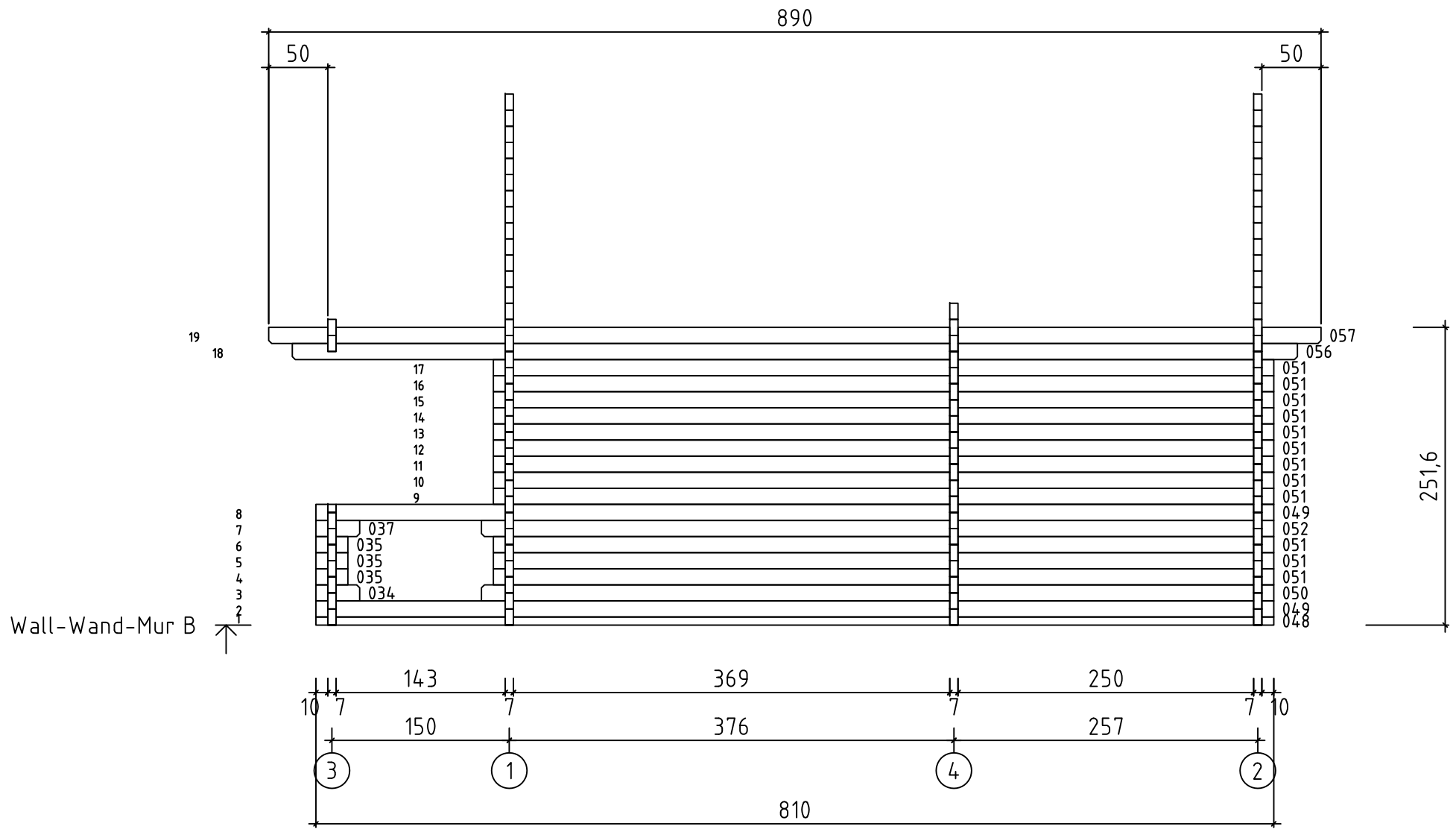

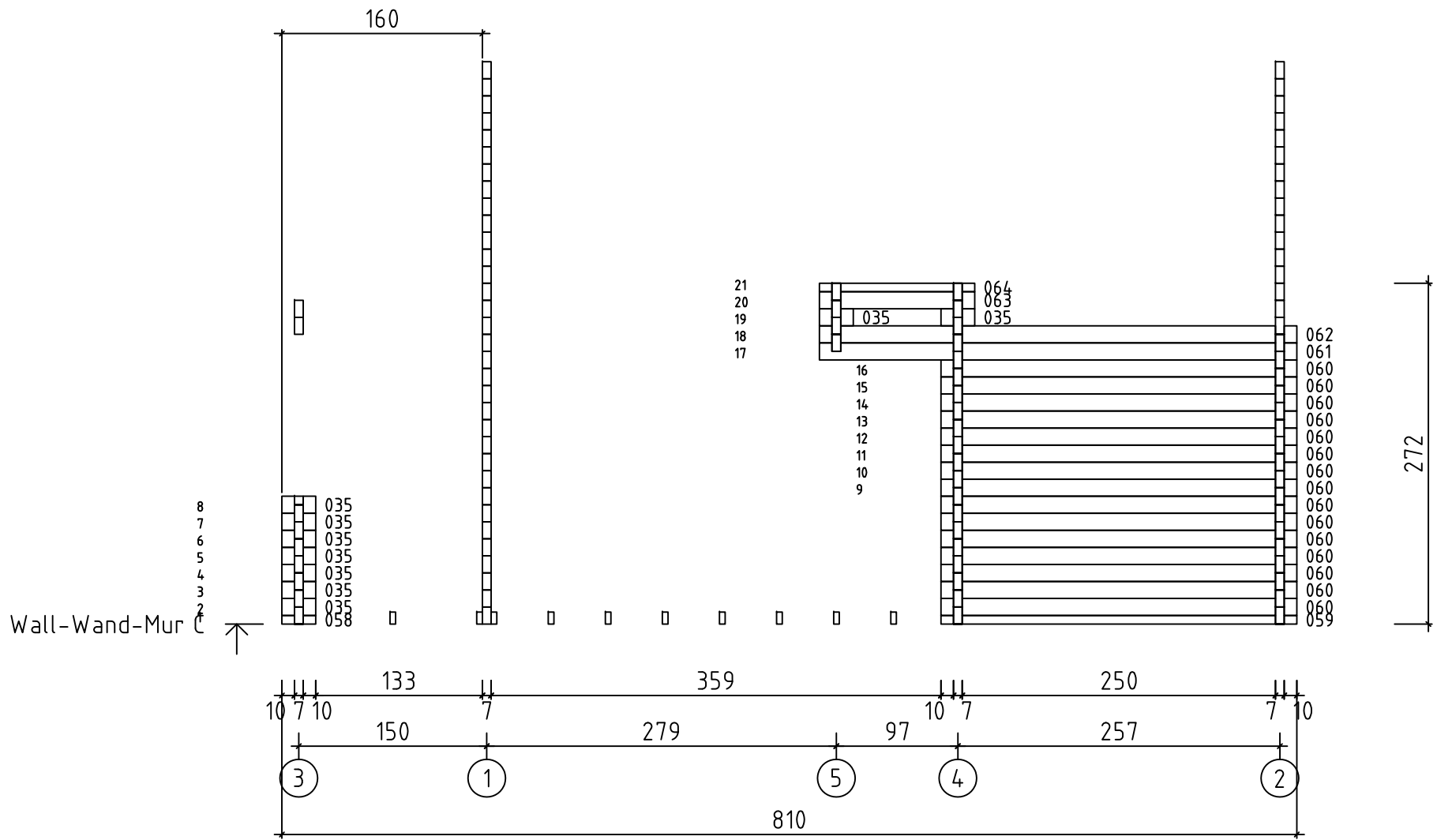

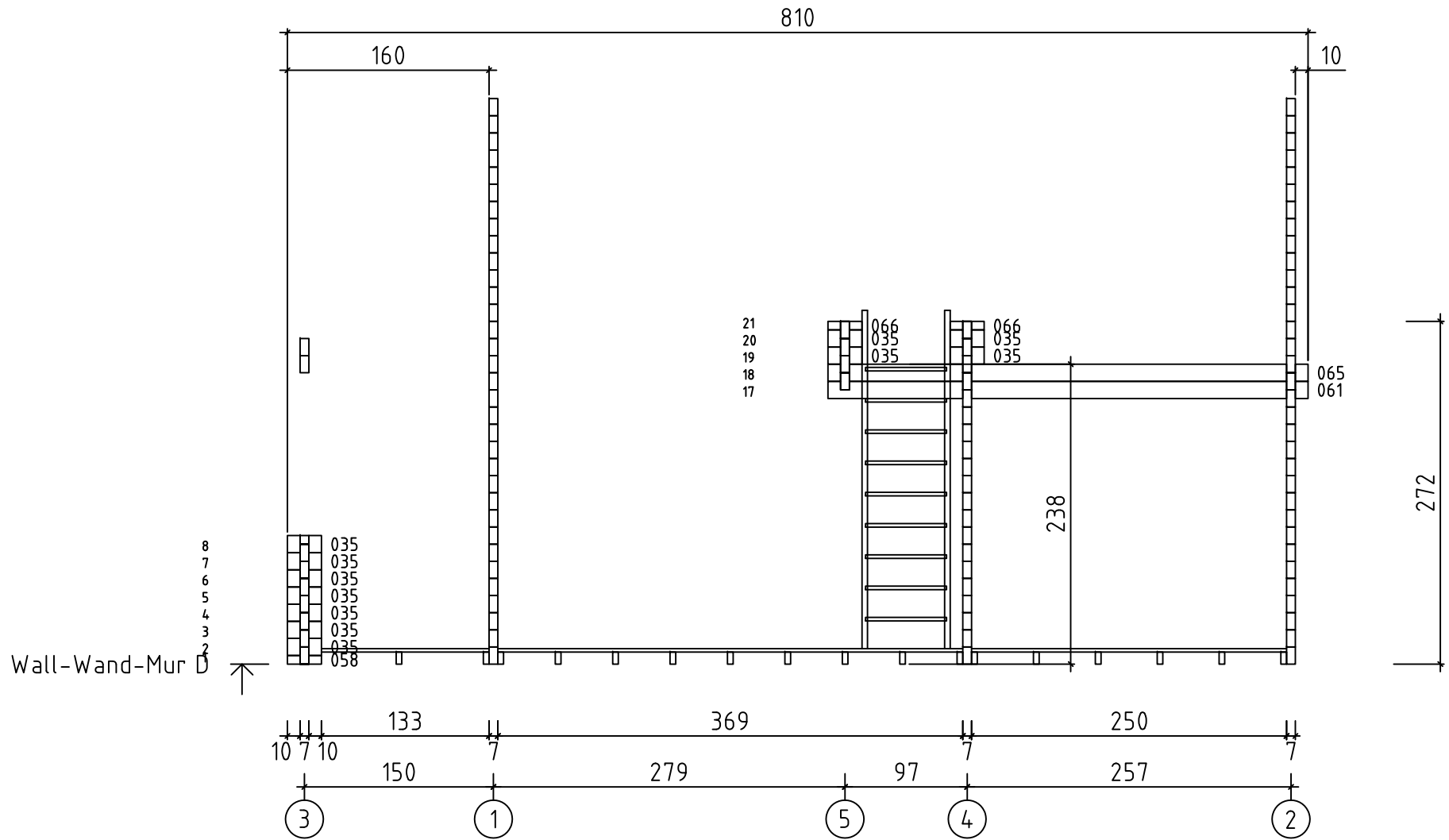

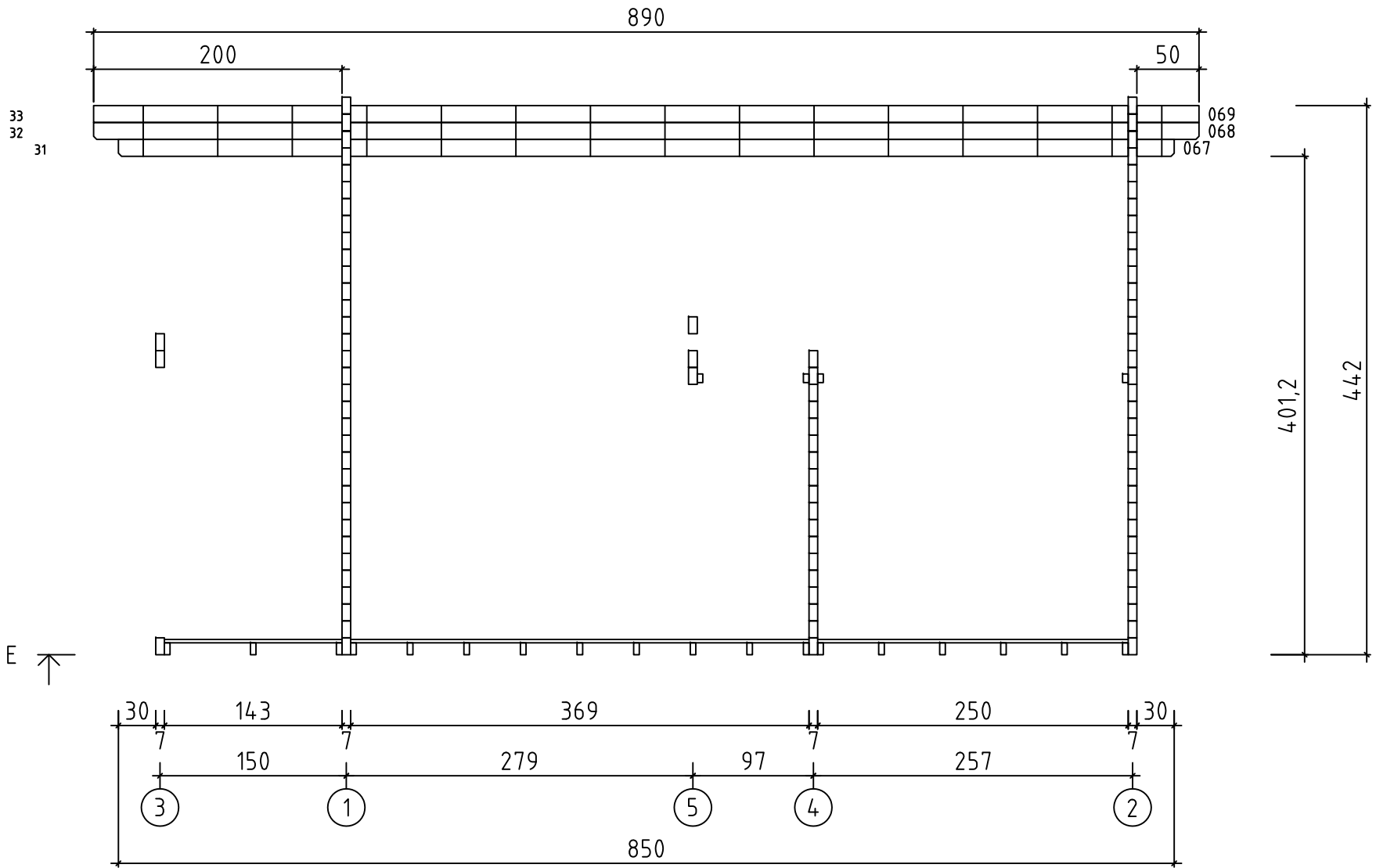

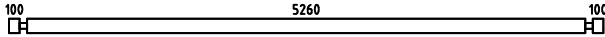
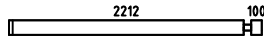

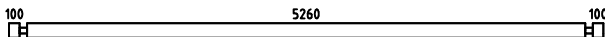
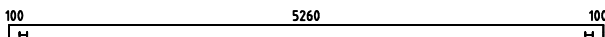
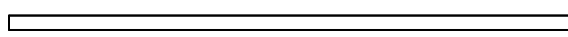
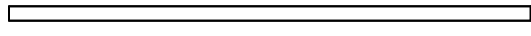
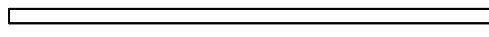
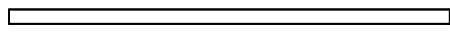
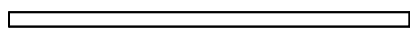
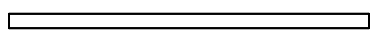
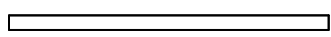
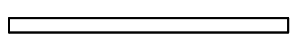
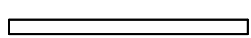
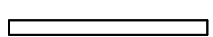
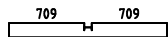
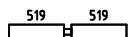

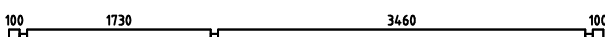



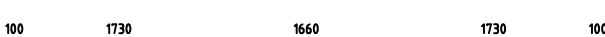

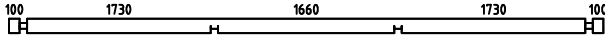
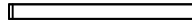
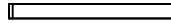
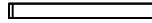
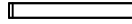
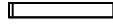
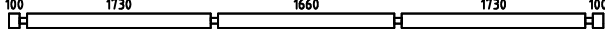





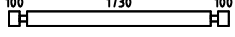
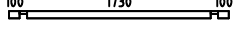
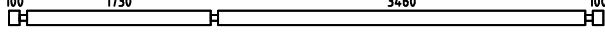

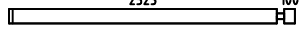
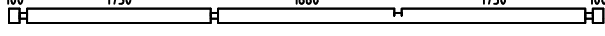
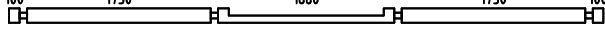

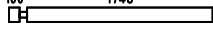
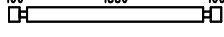
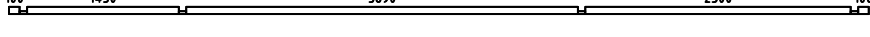
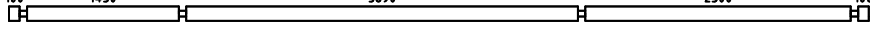
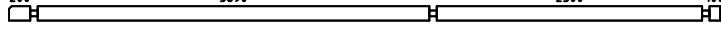

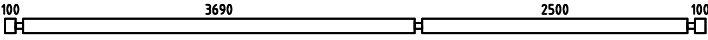
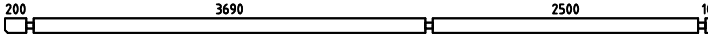
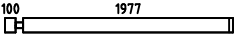
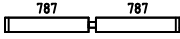
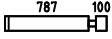
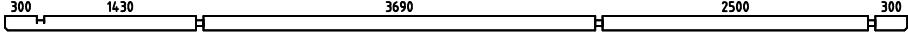
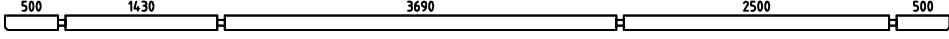

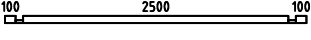
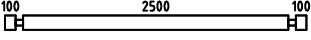
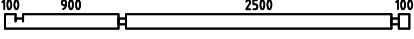
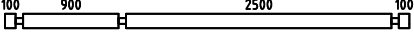
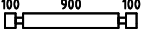
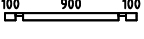
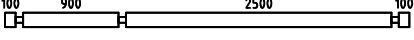

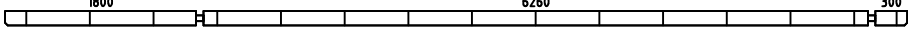
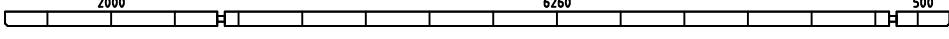
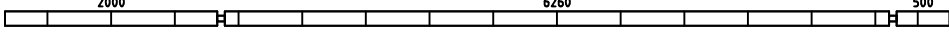
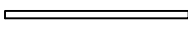
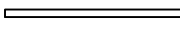
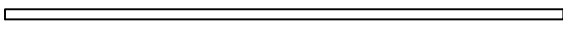
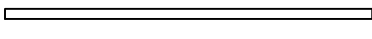
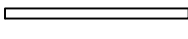
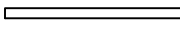

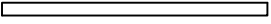









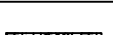

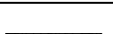
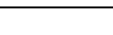









Pos	15.04.2011	ART.NR.060411.1UK	20/26	Q.	P (mm)	L (mm)
001				1	70x136	5600
002				12	70x136	2382
003				16	70x136	499
004				16	70x136	499
005				4	70x136	5600
006				3	70x136	5600
007				2	70x136	5296
008				2	70x136	4915
009				2	70x136	4534
010				1	70x136	4154
011				1	70x136	3773
012				1	70x136	3392
013				1	70x136	3011
014				1	70x136	2631
015				2	70x136	2250
016				2	70x136	1869
017				2	70x136	1489
018				2	70x136	1108
019				2	70x136	727
020				2	70x136	346
021				9	70x136	5600
022				6	70x136	3917
023				7	70x136	757
024				1	70x136	3917
025				2	70x136	5600

Pos	15.04.2011	ART.NR.060411.1UK	21/26	Q.	P (mm)	L (mm)
026				1	70x136	5600
027				2	70x136	1747
028				2	70x136	1556
029				2	70x136	1366
030				2	70x136	1176
031				2	70x136	985
032				1	70x136	5600
033				1	70x136	335
034				5	70x136	370
035				56	70x136	270
036				1	70x136	335
037				5	70x136	370
038				2	70x136	2070
039				2	70x68	2070
040				1	70x136	5600
041				14	70x136	800
042				14	70x136	2693
043				1	70x136	5600
044				1	70x136	5600
045				2	70x136	270
046				2	70x136	1918
047				3	70x136	2000
048				2	70x68	8100
049				4	70x136	8100
050				2	70x136	6700

Pos	15.04.2011	ART.NR.060411.1UK	22/26	Q.	P (mm)	L (mm)
051				17	70x136	6600
052				2	70x136	6700
053				7	70x136	2147
054				7	70x136	1644
055				7	70x136	957
056				2	70x136	8500
057				2	70x136	8900
058				2	70x68	270
059				1	70x68	2840
060				15	70x136	2840
061				2	70x136	3810
062				1	70x136	3810
063				1	70x136	1240
064				1	70x68	1240
065				1	70x136	3810
066				2	70x68	270
067				1	70x136	8500
068				1	70x136	8900
069				1	70x136	8900
AR1	 BEAM - BALKENLAGE - SOLIVE			4	45x70	1730
AR2	 BEAM - BALKENLAGE - SOLIVE			4	45x70	1660
PT3	FLOOR BEAMS - FUSSBODENBALKEN - LES POUTRES DE PLANCHER 			10	45x95	5260
PT2	FLOOR BEAMS - FUSSBODENBALKEN - LES POUTRES DE PLANCHER 			7	45x95	3460
PT1	FLOOR BEAMS - FUSSBODENBALKEN - LES POUTRES DE PLANCHER 			9	45x95	1730
PT4	FLOOR BEAMS - FUSSBODENBALKEN - LES POUTRES DE PLANCHER 			1	45x95	1660

Pos	15.04.2011	ART.NR.060411.1UK	23/26	Q.	P (mm)	L (mm)
VT1		BEAM - BALKENLAGE - SOLIVE		10	44x120	2500
VT2		BEAM - BALKENLAGE - SOLIVE		4	44x120	900
SR1		RAFTER - DACHSPARREN - CHEVRON		34	44x140	3933
FB		FLOOR BOARDS - FUSSBODENBRETTER - LAME DE PLANCHER 		61	87x28	3686
FB		FLOOR BOARDS - FUSSBODENBRETTER - LAME DE PLANCHER 		29	87x28	3493
FB1		FLOOR BOARDS - FUSSBODENBRETTER - LAME DE PLANCHER 		12	87x28	2700
FB		FLOOR BOARDS - FUSSBODENBRETTER - LAME DE PLANCHER 		61	87x28	2496
FB		FLOOR BOARDS - FUSSBODENBRETTER - LAME DE PLANCHER 		31	87x28	1763
FB		FLOOR BOARDS - FUSSBODENBRETTER - LAME DE PLANCHER 		9	87x28	1726
FB		FLOOR BOARDS - FUSSBODENBRETTER - LAME DE PLANCHER 		3	87x28	1656
FB		FLOOR BOARDS - FUSSBODENBRETTER - LAME DE PLANCHER 		2	87x28	1456
DB		ROOF BOARDS - DACHBRETTER - VOLIGES 		88	90x18	4578
DB		ROOF BOARDS - DACHBRETTER - VOLIGES 		72	90x18	4371
DB		ROOF BOARDS - DACHBRETTER - VOLIGES 		88	90x18	4322
DB		ROOF BOARDS - DACHBRETTER - VOLIGES 		72	90x18	1885
SV2		TERRACE BOARDS - TERRASSENBRETTER - PLANCHER DE TERRASSE 		41	120x28	1426
FL		FLOOR FILLET-FUSSBODENLEISTE - CORNIERE DE FINITION DU PLANCHER 			18x18	48.06
DPL		ROOFING FELT FILLET - DACHPAPPENLEISTE - BAGUETTE DE FIXATION DU FEUTRE BITUMEUX 		4	18x58	3945
M12		TREADED ROD M12 - GEWINDESTANGE M12 - TIGE FILETÉE M12 		15		450
P3		POST - PFOSTEN - POTEAU 		2	120x120	1212
P3		POST - PFOSTEN - POTEAU 		2	120x120	1280
TB2		EAVES BOARD - TRAUFBRETT - BANDEAU DE TOIT 		2	18x120	4322
TB2		EAVES BOARD - TRAUFBRETT - BANDEAU DE TOIT 		2	18x120	4578

Pos	15.04.2011	ART.NR.060411.1UK	24/26	Q.	P (mm)	L (mm)
TBE6	FIXING FILLET - FIXIRUNGSLEISTE - PROFIL DE FIXATION			2	28x34	660
TBE6	FIXING FILLET - FIXIRUNGSLEISTE - PROFIL DE FIXATION			6	28x34	932
TBE6	FIXING FILLET - FIXIRUNGSLEISTE - PROFIL DE FIXATION			4	28x34	1068
TBE6	FIXING FILLET - FIXIRUNGSLEISTE - PROFIL DE FIXATION			4	28x34	1884
TG1	GUARD-RAIL FOR TERRACE - TERRASSEN GELÄNDER - MAIN COURANTE DE TERRASSE			6	18x120	75
TG1	GUARD-RAIL FOR TERRACE - TERRASSEN GELÄNDER - MAIN COURANTE DE TERRASSE			2	18x120	1305
TG1	GUARD-RAIL FOR TERRACE - TERRASSEN GELÄNDER - MAIN COURANTE DE TERRASSE			2	18x120	2070
GL	GABLE MOULDING - GIEBELLEISTE - PLANCHE DE RIVE			4	18x120	3971
GL	GABLE MOULDING - GIEBELLEISTE - PLANCHE DE RIVE			4	18x120	4013
KL1	DRIVE NUT TREADED ROD - EINSHLAGMUTTER FÜR GEWINDESTANGE - ÉCROU A FRAPPER POUR TIGE FILLETÉE			15		
KL2	NUT FOR TREADED ROD - MUTTER FÜR GEWINDESTANGE - ÉCROU POUR TIGE FILETÉE			15		
KL3	PLAIN WASHER TREADED ROD - UNTERLEGSCHIEBE FÜR GEWINDESTANGE - RONDELLE PLATE POUR TIGE FILETÉE			15		
HS74	SCREW FOR FIXING FILLET OF DOOR - SCHRAUBEN FÜR FIXIRUNGSLEISTE VIS POUR PROFIL DE FIXATION DES PORTES			36	3.5x50	
HS37	SCREW FOR POST - SCHRAUBEN FÜR PFOSTEN - VIS DE FIXATION DES POTEAUX			8	4.5x80	
HS73	SCREW FOR STEELPLATE - SCHRAUBEN FÜR METALLPLATE VIS POUR PLAQUE MÉTALLIQUE DE FIXATION			918	4x40	
HS7	SCREW FOR METAL CORNER - HOLZSCHRAUBE FÜR METALWINKEL VIS POUR COIN EN MÉTAL			700	4x40	
HS32	SCREW FOR EAVES BOARDS - SCHRAUBEN FÜR TRAUFBRETTEN - VIS DE FIXATION POUR BANDEAU DE TOIT			34	4x40	
HS30	SCREW FOR TERRACE REAR BOARDS - SCHRAUBEN FÜR TERRASSEN RAND VIS DE FIXATION POUR MAIN COURANTE DE TERRASSE			26	4x40	
HS36	SCREW FOR STEPLADDER - SCHRAUBE FÜR LEITER VIS D'ASSEMBLAGE DES MARCHES DE L'ECHELLE			40	4x60	
HS75	SCREW FOR BEAM - SCHRAUBEN ZUR BEFESTIGUNG DACHSPARREN VIS POUR SOLIVE			40	5x100	
HS39	SCREW FOR FUNDAMENT - SCHRAUBEN ZUR BEFESTIGUNG FUNDAMENT - VIS POUR FONDATION			54	5x120	
HS52	SCREW FOR BEAM - SCHRAUBEN ZUR BEFESTIGUNG DACHSPARREN VIS POUR SOLIVE			28	5x120	
HS49	SCREW FOR POST HEIGHT ADJUSTMENT SCHRAUBEN FÜR REGULIERUNGSSCHRAUBE FÜR PFOSTEN VIS DE FIXATION DE SUPPORT REGLABLE			32	6x50	
HS76	SCREW FOR BOARDS - SCHRAUBEN ZUR BRETTEN - VIS POUR PLANCHER			120	6x60	
KR	STEELPLATE -METALLPLATE - PLAQUE MÉTALLIQUE DE FIXATION			17	200x100x2.0	

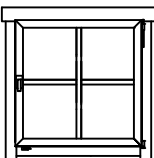
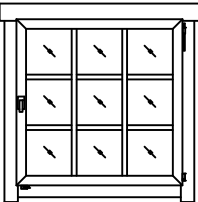
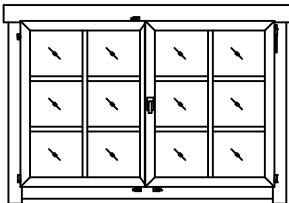
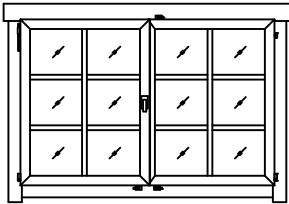
Pos	15.04.2011	ART.NR.060411.1UK	25/26	Q.	P (mm)	L (mm)
SH70	HAMMER BLOCK - SCHLAGHOLZ - CALLE DE FRAPPE			1		
MW2	METAL CORNER - METALLWINKEL - CORNIERE EN MÉTAL			51		
LR	LADDER - LEITER - ECHELLE			1		
NF2	ZN NAIL FOR ROOF - ZN NÄGEL FÜR DACHBRETTER - POINTE POUR TOIT			2500	2.1x50	
NH1	ZN NAIL FOR FLOOR - ZN NÄGEL FÜR FUSSBODENBRETTER - CLOUS POUR PLANCHER			1400	2.1x50	
RFP	POST HEIGHT ADJUSTMENT - REGULIERUNGSSCHRAUBE FÜR PFOSTEN - SUPPORT RÉGLABLE DE POTEAU			4		
	AK.1.104.PSP.7	WINDOW 650x650		1		
						
	AK.1.109.PSP.7	WINDOW 916x916		3		
						
	TAK.1.106.PSP.7b	WINDOW 1374x1050		1		
						
	TAK.1.106.PSV.7b	WINDOW 1374x1050		1		
						

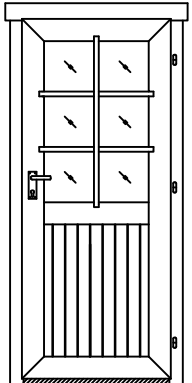
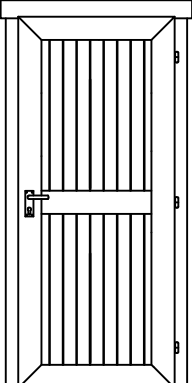
Pos	15.04.2011	ART.NR.060411.1UK	26/26	Q.	P (mm)	L (mm)
	UK.2.056.PVP.MM7	D00R 827x1865 		1		
	UL.2.100.IVP.MM7	D00R 827x1865 		1		